

# A Technical Guide for Static Headspace Analysis Using GC



**Inside:**

*Basic Principles of Headspace  
Analysis*

*Instrumentation*

*System Optimization  
(Troubleshooting)*

*Headspace Applications*

*Recommended Headspace Analysis  
Products*

## Table of Contents

### Introduction ..... 2

### Basic Principles of Headspace

#### Analysis ..... 3

- Partition Coefficient
- Phase Ratio
- Combining K and  $\beta$
- Derivatization/Reaction Headspace
- Headspace Sample Size

#### Instrumentation ..... 6

- Gas-Tight Syringe Injection
- Balanced-Pressure System
- Pressure-Loop System

### System Optimization

#### (Troubleshooting) ..... 8

- Sample Preparation
- Sample Vial
- Sample Vial Heater and Mixer
- Sampling
- Transfer Line
- Injection Port Interface

#### Headspace Applications ..... 11

- Blood Alcohol Analysis
- USP <467>
- European Pharmacopoeia Tests

#### Recommended Headspace Analysis Products ..... 15

- Capillary Columns
- Guard Columns
- Press-Tight® Connectors
- Analytical Reference Materials
- GC Accessories

For technical support, call  
**800-356-1688, ext. 4**  
 (814-353-1300, ext. 4)

or call your local  
 Restek representative.

Static headspace gas chromatography (GC) is a technique used for the concentration and analysis of volatile organic compounds. This technique is relatively simple and can provide sensitivity similar to dynamic purge and trap analysis. The popularity of this technique has grown and has gained worldwide acceptance for analyses of alcohols in blood and residual solvents in pharmaceutical products. Other common applications include industrial analyses of monomers in polymers and plastic, flavor compounds in beverages and food products, and fragrances in perfumes and cosmetics.

Sample matrices like blood, plastic, and cosmetics contain high molecular weight, non-volatile material that can remain in the GC system and result in poor analytical performance. Many laboratory analysts use extensive sample preparation techniques to extract and concentrate the compounds of interest from this unwanted non-volatile material. These extraction and concentration techniques can become time consuming and costly. Static headspace analysis avoids this time and cost by directly sampling the volatile headspace from the container in which the sample is placed.

Because of the diversities in the industry and related products, this guide attempts to cover only the basic principles of static headspace and demonstrate how to apply them to achieve optimum chromatographic results. With an understanding of these principles, various instrumentation will then be reviewed to help build upon this knowledge and identify the benefits and potential problems associated with each mode of sample transfer. Information from the *Basic Principles* and *Instrumentation* sections of this guide can then be brought together and applied to the conditions and methodology of common analyses. Like most applications, a variety of problems may arise in which the *System Optimization* section will help to identify these problems and offer techniques to help resolve them.

**Time and money are two of the many reasons why an analyst would use static headspace analysis. Other reasons may include ease of operation and the ability to assay a variety of sample matrices.**



## Basic Principles of Headspace Analysis

Most consumer products and biological samples are composed of a wide variety of compounds that differ in molecular weight, polarity, and volatility. For complex samples like these, headspace sampling is the fastest and cleanest method for analyzing volatile organic compounds. A headspace sample is normally prepared in a vial containing the sample, the dilution solvent, a matrix modifier, and the headspace (see **Figure 1**). Volatile components from complex sample mixtures can be extracted from non-volatile sample components and isolated in the headspace or vapor portion of a sample vial. An aliquot of the vapor in the headspace is delivered to a GC system for separation of all of the volatile components.

In order to achieve the best performance when using headspace/GC, careful attention should be used in sample preparation and instrument setup. Key issues to address when setting up headspace/GC systems include minimizing system dead volume, maintaining inert sample flow paths, and achieving efficient sample transfer. These issues, as well as other instrument setup-related topics, are addressed later in the *System Optimization* section of this guide.

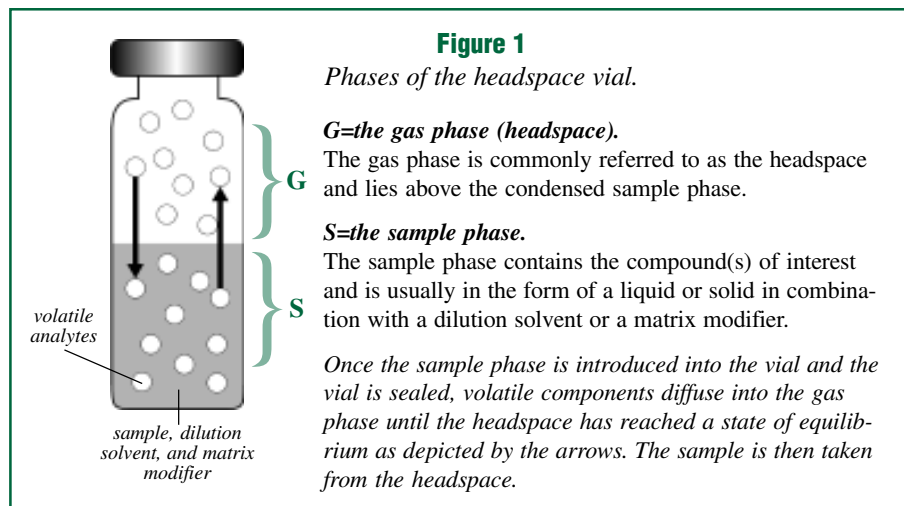

**Figure 2**  
*K and  $\beta$  are important variables in headspace analysis.*

**Equation 1**  
Partition Coefficient ( $K$ ) =  $C_s/C_g$

**Equation 2**  
Phase Ratio ( $\beta$ ) =  $V_g/V_s$

$C_s$ =concentration of analyte in sample phase  
 $C_g$ =concentration of analyte in gas phase  
 $V_s$ =volume of sample phase  
 $V_g$ =volume of gas phase

### Partition Coefficient

Samples must be prepared to maximize the concentration of the volatile components in the headspace, and minimize unwanted contamination from other compounds in the sample matrix. To help determine the concentration of an analyte in the headspace, you will need to calculate the partition coefficient ( $K$ ), which is defined as the equilibrium distribution of an analyte between the sample phase and the gas phase (**Figure 2**).

Compounds that have low  $K$  values will tend to partition more readily into the gas phase, and have relatively high responses and low limits of detection (**Figure 3**). An example of this would be hexane in water: at 40°C, hexane has a  $K$  value of 0.14 in an air-water system. Compounds that have high  $K$  values will tend to partition less readily into the gas phase and have relatively low response and high limits of detection. An example of this would be ethanol in water: at 40°C, ethanol has a  $K$  value of 1355 in an air-water system. Partition coefficient values for other common compounds are shown in **Table I**.

**Table I**  
*K Values of Common Solvents in Air-Water Systems at 40°C*

Solvent	K Value
cyclohexane	0.077
n-hexane	0.14
tetrachloroethylene	1.48
1,1,1-trichloromethane	1.65
o-xylene	2.44
toluene	2.82
benzene	2.90
dichloromethane	5.65
n-butyl acetate	31.4
ethyl acetate	62.4
methyl ethyl ketone	139.5
n-butanol	647
isopropanol	825
ethanol	1355
dioxane	1618

**Figure 3**

Sensitivity is increased when  $K$  is minimized.

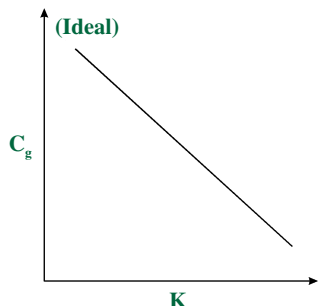
**Figure 4**

Sensitivity is increased when  $\beta$  is minimized.

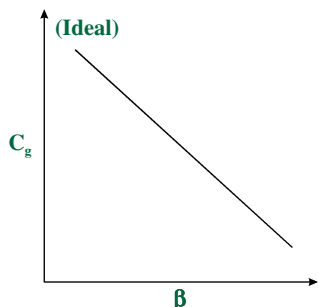

$K$  can be lowered by changing the temperature at which the vial is equilibrated or by changing the composition of the sample matrix. In the case of ethanol,  $K$  can be lowered from 1355 to 328 by raising the temperature of the vial from 40°C to 80°C. It can be lowered even further by introducing inorganic salt into the aqueous sample matrix. High salt concentrations in aqueous samples decrease the solubility of polar organic volatiles in the sample matrix and promote their transfer into the headspace, resulting in lower  $K$  values. However, the magnitude of the salting-out effect on  $K$  is not the same for all compounds. Compounds with  $K$  values that are already relatively low will experience very little change in partition coefficient after adding a salt to an aqueous sample matrix. Generally, volatile polar compounds in polar matrices (aqueous samples) will experience the largest shifts in  $K$  and have higher responses after the addition of salt to the sample matrix. **Table II** lists most of the common salts used for salting-out procedures.

**Table II**

Common salts used to decrease matrix effects.

ammonium chloride  
ammonium sulfate  
sodium chloride  
sodium citrate  
sodium sulfate  
potassium carbonate

#### Phase Ratio

The phase ratio ( $\beta$ ) is defined as the relative volume of the headspace compared to volume of the sample in the sample vial (**Figure 2**). Lower values for  $\beta$  (i.e., larger sample size) will yield higher responses for volatile compounds (**Figure 4**). However, decreasing the  $\beta$  value will not always yield the increase in response needed to improve sensitivity. When  $\beta$  is decreased by increasing the sample size, compounds with high  $K$  values partition less into the headspace compared to compounds with low  $K$  values, and yield correspondingly smaller changes in  $C_g$ . Samples that contain compounds with high  $K$  values need to be optimized to provide the lowest  $K$  value before changes are made in the phase ratio.

#### Combining $K$ and $\beta$

Partition coefficients and phase ratios work together to determine the final concentration of volatile compounds in the headspace of sample vials. The concentration of volatile compounds in the gas phase can be expressed as  $C_g = C_o / (K + \beta)$  (where  $C_g$  is the concentration of volatile analytes in the gas phase and  $C_o$  is the original concentration of volatile analytes in the sample). Striving for the lowest values for both  $K$  and  $\beta$  will result in higher concentrations of volatile analytes in the gas phase and, therefore, better sensitivity (**Figure 5**).

**Figure 5**

Lower  $K$  and  $\beta$  result in higher  $C_g$  and better sensitivity.

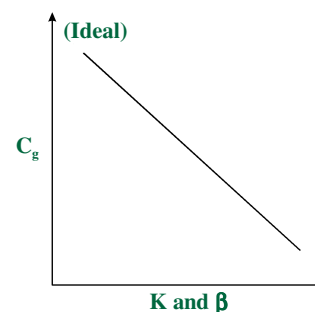

For customer service, call  
**800-356-1688, ext. 3**  
(814-353-1300, ext. 3)

or call your local  
Restek representative.

### Derivatization/Reaction Headspace

Derivatization is another technique that can be used to increase sensitivity and chromatographic performance for specific compounds. Compounds such as acids, alcohols, and amines are difficult to analyze because of the presence of reactive hydrogens. When attempting to analyze these types of compounds, they can react with the surface of the injection port or the analytical column and result in tailing peaks and low response. In addition, they may be highly soluble in the sample phase, causing very poor partitioning into the headspace and low response. Derivatization can improve their volatility, as well as reduce the potential for surface adsorption once they enter the GC system.

Common derivatization techniques used in reaction headspace/GC are esterification, acetylation, silylation, and alkylation. Any of these derivatization techniques can be performed using the sample vial as the reaction vessel (see **Table III** for a list of commonly used reagents). Although derivatization may improve chromatographic performance and volatility for some compounds, derivatization reactions may introduce other problems into the analytical scheme. Derivatization reagents as well as the by-products from derivatization reaction may be volatile and can partition into the headspace along with derivatized compounds. These extra volatile compounds may pose problems by eluting with similar retention times as the compounds of interest, causing either partial or complete coelutions.

Derivatization reactions also are typically run at elevated temperatures. Pressures inside the sample vial may exceed the pressure handling capabilities of the vial or the septa. Specially designed septa are available that allow excess pressure to be vented during derivatization reactions.

**Table III**

*Common reagents used to derivatize compounds of interest.*

Compound of Interest	Derivatizing Reagent	Resulting Derivative
fatty acids	methanol with boron trifluoride	esterification
glycerol	acetic anhydride with sodium carbonate	acetylation

*For more information on derivatization, please refer to the "Handbook of Analytical Derivatization Reactions" by Daniel R. Knapp or to the text at right.*

### Headspace Sample Size

In addition to working with  $K$ ,  $\beta$ , and derivatization reactions, sensitivity also can be improved by simply increasing the size of the headspace sample that is withdrawn from the sample vial and transferred to the GC. Increasing the sample size also means that the amount of time it takes to transfer the sample to the column will increase in proportion to the column volumetric flow rate. Sample size can be increased only to the point that increases in peak width, as a result of longer sample transfer times, will not affect chromatographic separations. Larger sample sizes and longer transfer times can be offset by using cryogenic cooling and sample refocusing at the head of the column.

For more information on headspace analysis, check out the textbook, **Static Headspace-Gas Chromatography, Theory and Practice** by Bruno Kolb and Leslie S. Ettre.

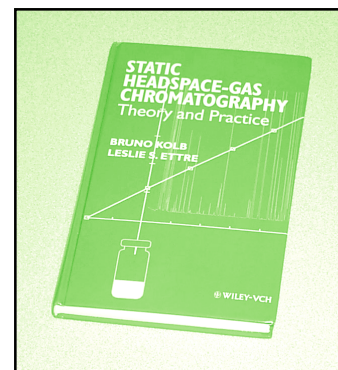

## Instrumentation

### Gas-Tight Syringe Injection

Use of a gas-tight syringe autosampling system is one of three common techniques (gas-tight syringe, balanced pressure, and pressure loop) used to transfer a headspace sample. Most of the autosampling units can retrofit to a standard GC with a split/splitless injection port, making them relatively simple to use and understand. These systems do not require the use of special configurations or special instrumentation other than the autosampler itself. The gas-tight syringe autosampler is beneficial for use with diverse samples because of the variety of sampler configurations and method options available.

The gas-tight syringe technique operates by initially thermostating the sample in an incubation oven at a given temperature and for a given time until it has reached a state of equilibrium (**Figure 6, Step 1**). Once the sample has reached an equilibrium, an aliquot is taken from the headspace using the gas-tight syringe (**Figure 6, Step 2**), and the aliquot is injected into the GC as if it were a liquid sample injection (**Figure 6, Step 3**).

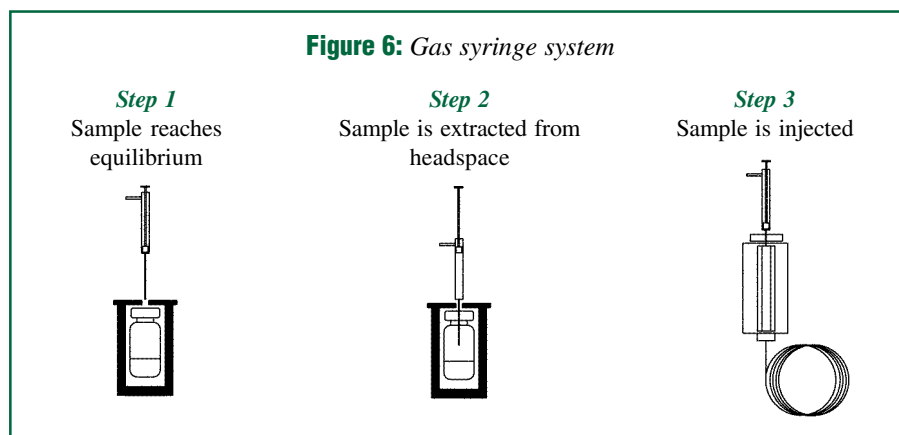

**Figure 7**

*Gas-tight syringe autosampler  
TRACE HS850*

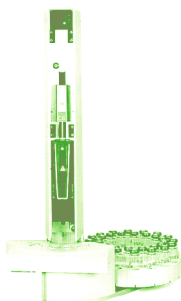

Several concerns exist regarding this technique. Because the sample is being transferred from a heated oven, the syringe also must be heated to ensure that the sample will not recondense in the syringe. Many manufacturers have taken this into consideration and their samplers now come with a heated syringe assembly. There also are reproducibility issues because of possible sample loss. As the sample is transferred from the vial to the injection port, some of it may be lost because of the pressure differences between the vial and atmospheric conditions. Beyond these concerns, the gas-tight syringe technique is simple to use, can retrofit into a variety of GC systems, and is best suited for diverse samples. Examples of manufacturers and models of the gas-tight syringe units are: the ThermoQuest TRACE™ HS2000 and HS850 (**Figure 7**) Headspace Autosamplers and the Leap Technologies CTC COMBI PAL Sampler.

### Balanced-Pressure System

Another common technique is the balanced-pressure system, which is capable of generating results with a high degree of repeatability. It uses a seamless injection directly from the vial into the carrier gas stream without additional moving parts other than a valve and a needle. The balanced-pressure system, like other techniques, uses an incubation oven to thermostat the vial so the sample reaches equilibrium (**Figure 8, Step 1**). During these initial steps, a needle is inserted into the vial and then is pressurized with a carrier gas (**Figure 8, Step 2**). After the vial is pressurized and equilibrium has been reached, the valve is switched for a specific amount of time to redirect the sample into the transfer line and onto the column (**Figure 8, Step 3**).

**Figure 8:** *Balanced-pressure system*

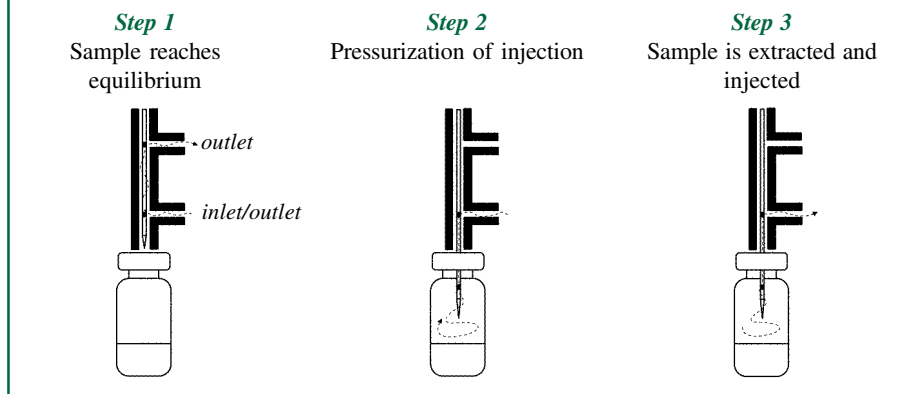

Because this technique uses a theoretical amount of time to inject the sample, the absolute volume of the sample is unknown. However, this technique is highly reproducible because the number of moving parts are minimized, which decreases the chance for compound adsorption and loss via leaks. An example of a balanced-pressure system is the HS 40XL manufactured by Perkin-Elmer (**Figure 9**).

**Figure 9**  
*Balanced-pressure autosampler*  
*Perkin-Elmer HS 40XL*

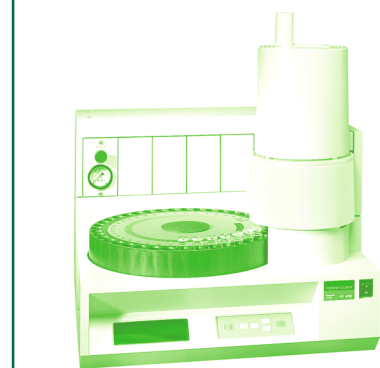

### Pressure-Loop System

The last common injection technique discussed in this guide is the pressure-loop system. Unlike balanced-pressure, the pressure-loop system uses a known amount of sample. This technique typically uses a six-port valve, and initially thermostats and pressurizes the vial as in the previously described techniques (**Figure 10, Step 1**). After pressurization, the valve is turned and the loop is filled with the sample (**Figure 10, Step 2**). After the loop has been filled, the valve is turned again to redirect the gas flow and flush the sample into the transfer line leading to the analytical column (**Figure 10, Step 3**).

**Figure 10:** *Pressure-loop system*

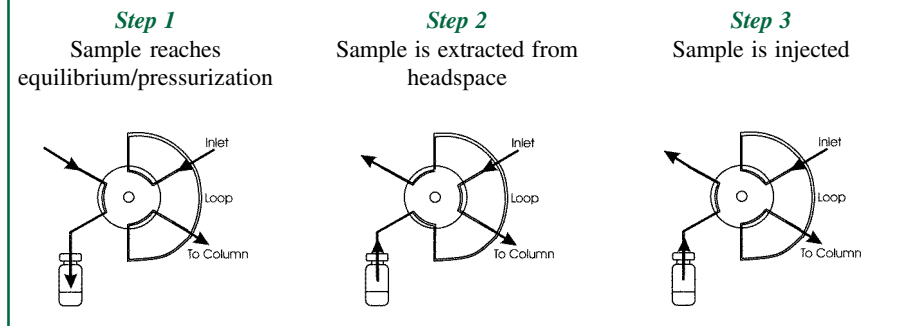

The pressure-loop system has several advantages and disadvantages. One of the advantages of this system is that the loop can be thermostatted to high temperatures, which helps to lessen adsorption of higher molecular weight and sensitive compounds. The fixed volume of the sample loop also helps to improve run-to-run reproducibility. A disadvantage of a pressure-loop system is that it may cause ghost peaks because of sample carryover from a previous analysis.<sup>1</sup> Several makes and models of pressure-loop systems include the OI Model 4632 (**Figure 11**), Varian Genesis, Tekmar 7000HT, and the HP 7694E.

**Figure 11**  
*Pressure-loop system*  
*OI Model 4632*

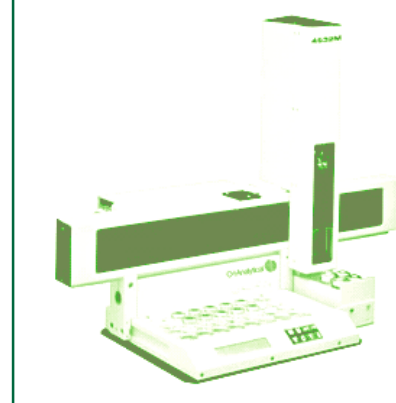

## System Optimization (Troubleshooting)

Chromatographic performance in Headspace/GC is greatly influenced by how the sample is introduced into the analytical column. Variables that affect sample preparation and transfer of the sample from the headspace unit to the analytical column must be optimized to obtain reproducible and efficient separations. Key issues to address when setting up headspace/GC systems include minimizing system dead volume, maintaining inert sample flow paths, and achieving efficient sample transfer. This section will explain how to optimize areas that are critical in addressing these issues and providing good chromatographic performance.

### Sample Preparation

Samples for headspace/GC must be prepared in such a manner as to maximize the concentration of the volatile sample components in the headspace while minimizing unwanted contamination from other compounds in the sample matrix. Sample matrices such as biological samples, plastics, and cosmetics can contain high molecular weight, volatile material that can be transferred to the GC system. Water from the sample matrix also can cause problems by recondensing in the transfer line. Incomplete or inefficient transfer of high molecular weight compounds or water vapor from sample matrices can produce adsorptive areas in the transfer line or injection port that can lead to split peaks, tailing peaks, or irreproducible responses or retention times. To minimize matrix problems and prevent water condensation from aqueous samples, use a higher transfer line temperature (~125°C–150°C).

High-concentration samples need to be prepared appropriately to obtain optimal chromatography. High-concentration samples can produce ghost peaks in subsequent analyses due to carryover of sample from previous injections. Sample carryover can be minimized by using higher transfer line and injection port temperatures, but some samples may need to be diluted and re-analyzed to obtain reliable results. Additionally, we recommend injecting standards and samples in order from low to high concentrations to help minimize carryover. When sample carryover or ghost peaks are evident, you may need to bake-out the column at its maximum operating temperature and elevate the transfer line temperature in order to remove all of the residual sample. If high-concentration samples are anticipated in a sequence of samples, running a blank after the suspected samples will reduce carryover contamination of following ones. It is good lab practice to handle standards and method blanks the same way samples are handled to make any vial or sample preparation problems easier to identify.

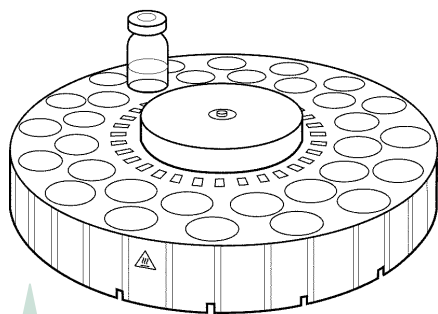

*Always use pre-cleaned vials for sample preparation and storage.*

### Sample Vial

Sample vials should be selected to match the type and size of the sample being analyzed. Always use pre-cleaned vials for sample preparation and storage. Vials that are not properly cleaned prior to packaging or that absorb contaminants during shipping can produce unknown chromatographic peaks, or “ghost peaks.” Ghost peaks that are the result of vial contamination can be identified by running method blanks and zero standards during the system calibration sequence.

The septa used to seal the headspace vials also can be a source for contaminants, which can bleed into the headspace of the vial during equilibration. These contaminants can appear as single peaks or multiple peak patterns. Some septa are available with a PTFE face to eliminate bleed from the rubber portion of the septa. These septa should not be re-used. Once the PTFE face has been punctured by a syringe, contaminants from the rubber portion of the septa can migrate into the headspace and show up as unidentified peaks. Again, the use of method blanks can help to determine the source of contaminants.



### Sample Vial Heater and Mixer

Once the sample is placed inside a clean, non-contaminating vial and the vial is sealed, volatile compounds from the sample will partition into the headspace until a state of equilibrium is reached. The rate at which volatile compounds partition out of the sample matrix and into the headspace, as well as the equilibrium concentration of volatile compounds in the headspace depends on several parameters (see also *Introduction* of this guide).

Temperature, time, and mixing can be used to improve the transfer of volatile analytes from the sample into the headspace of the vial. Adjusting the temperature of the sample will change the solubility of the analyte in the sample matrix and can be used to drive the equilibrium in favor of the gas phase. Sufficient time must be built into the sample cycle in order to achieve a constant state of equilibrium. Some sample matrices require longer equilibration times due to physical characteristics like high viscosity. Shaking or vibrating the vial during heating can assist in achieving equilibrium more quickly by exposing more sample surface area for the transfer of volatile analytes to the headspace.

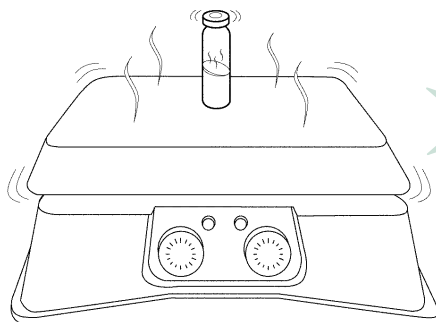

*Shaking or vibrating the vial during heating can assist in achieving equilibrium.*



### Sampling

There are several techniques used to transfer samples from the vial to the GC. When using a *gas-tight syringe* for sampling, heat the syringe to a temperature comparable to the sample vial temperature. This minimizes pressure differences and condensation problems. To prevent carryover from inside the syringe, flush the syringe after each injection. Because gas-tight syringe samplers inject through the GC injection port septum, ensure the septum is well maintained to decrease the possibility of a leak.

For *balanced-pressure sampling* instruments, analysts should consider the inertness and efficiency of the components that make up the sample pathway inside the autosampler. If sensitive compounds are being analyzed, an inert pathway should be used to decrease possible adsorption. Materials such as stainless steel, nickel, Silcosteel® and PTFE coatings, or KEL-F® parts can be used to minimize sample adsorption and peak tailing. Transfer line internal diameter should be as narrow as possible to help maintain narrow sample band widths and symmetrical peak shapes (see the following optimization of transfer lines for more information). Analysts also should ensure that balanced-pressure instruments are leak-free and operate with the least amount of dead volume in the sample flow path. This will help obtain optimal peak shape and sensitivity.

When using *pressure-loop sampling* instruments, the same concerns apply as with gas-tight syringe and balanced-pressure systems. Inert sample pathways and low dead volume systems will yield the best chromatographic performance. In pressure-loop systems, a gas sampling valve with a sample loop is used to transfer the sample from the headspace unit to the GC. Adequate purging of the sample valve and loop will guard against sample carryover. If low response or broad peaks are observed, it may be necessary to increase the sample vial pressure to ensure that the sample loop is being completely filled with headspace sample. If there are extraneous peaks present due to carryover of matrix contaminants, increase the sample valve temperature to prevent sample carryover, condensation, and contamination.

For technical support, call  
**800-356-1688, ext. 4**  
 (814-353-1300, ext. 4)

or call your local  
 Restek representative.

### Transfer Line

After the headspace sample is withdrawn from the vial, it ready to be transferred to the GC. In balanced-pressure and pressure-loop systems a short piece of tubing called a transfer line is used to transfer the sample from the autosampler to the GC. Transfer line material must be chosen that suits the sample analytes. Many different materials can be used as transfer line tubing, including stainless steel, nickel, fused silica, and Silcosteel®- or Siltek™-coated tubing. Stainless steel provides a strong, flexible tubing material, but can be adsorptive towards more active analytes such as alcohols, diols, and amines. Nickel and Silcosteel® tubing are highly inert towards active compounds and provide ruggedness similar to stainless steel. Fused silica and Siltek™ tubing are extremely inert towards active compounds, however they are not as rugged as nickel or Silcosteel® tubing.



*Use an inert transfer line when optimizing pressure-loop systems.*

The internal diameter of the transfer line should be chosen depending on the internal diameter of the analytical column, the column flow rate, and the flow rate delivered from the autosampler. To eliminate tubing dead volume, use the smallest diameter tubing possible. For example, compound residence time in a 1.0mm ID transfer line is 3.6 times greater than in the same length of 0.53mm ID tubing. Reducing the residence time of the headspace sample in the transfer line helps to minimize band broadening. Therefore, the flow rate should be set as high as possible to quickly move the sample cloud through the tubing and minimize any dead volume effects.

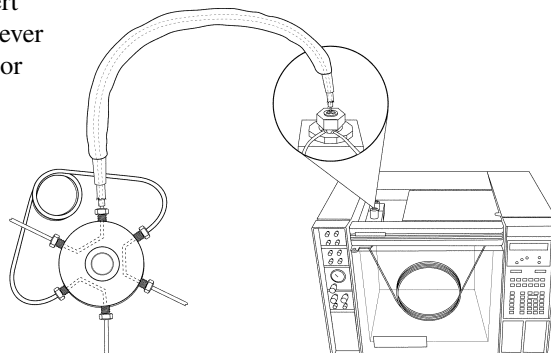

Transfer line temperature should be set depending on the analytes of interest and the sample matrix. Typical transfer line temperatures range from 80°C to 125°C. To minimize matrix problems and prevent water condensation from aqueous samples, use a higher transfer line temperature (~125°C to 150°C).

### Injection Port Interface

The quality of the connection of the transfer line to the analytical column greatly affects sample bandwidth. In most cases, the transfer line has a smaller internal diameter than the injection port liner, and the vaporized headspace sample carrying the compounds of interest will be diluted into a larger volume of carrier gas when the sample elutes from the transfer line into the inlet liner. This can lead to broader peaks, tailing peaks, lower sensitivity, and loss of resolution. Because headspace samples are already in a gaseous state (vapor cloud) when they enter the injection port, there is no need to use a large buffer volume in the liner to allow for sample expansion as when analyzing liquid samples. Using injection port liners that have smaller internal diameters and lower buffer volumes will help maintain a narrow bandwidth as samples move from the end of the transfer line to the head of the analytical column. 1.0mm ID deactivated injection port liners are recommended for most headspace applications to achieve the lowest injection port dead volume.

If band-broadening due to excess dead volume in the system is still a problem, peak shape may be improved by refocusing sample analytes at the analytical column head. Highly volatile compounds can be trapped at the column head and refocused into a narrow bandwidth by reducing the initial oven temperature below the boiling point of compounds of interest. After the sample is completely transferred to the column, the oven temperature can be increased to move the compounds through the column.

**Restek's technical service is here to help. If you still have questions after reviewing this guide, please call us at 800-356-1688 or 814 353-1300, ext. 4, or call your local Restek representative.**

## Headspace Applications

### Blood Alcohol Analysis

Analysis time and resolution are two critical factors when developing a GC assay for ethanol. Analysis time for each sample should be as short as possible while still maintaining baseline resolution for all analytes. Isothermal analysis is the method of choice because it eliminates the cool-down period between temperature-programmed runs. Overall analysis time can be reduced in isothermal analysis by raising the oven temperature or by increasing carrier gas flow rate. However, in attempting to shorten the analysis time, either by increasing the flow rate or raising the temperature, many traditional capillary column stationary phases fail to provide adequate resolution of all the components commonly tested during blood alcohol analysis. Current advances have aided in the design of two novel capillary column stationary phases to meet all of these requirements—the Rtx<sup>®</sup>-BAC1 and the Rtx<sup>®</sup>-BAC2 columns.

### Quantitation Technique for Blood Alcohol Analysis (Internal Standard)

The internal standard technique uses one or more designated compounds at known concentrations spiked into the sample. The response of the compounds of interest are then compared to the results of the internal standard. There are several advantages to this technique. Multiple injections of the standard are not necessary for concentration calculations; small changes in injection volumes or detector response over time can be determined.

**Figure 12**

Achieve baseline resolution of all blood alcohol components in less than 3 minutes using the Rtx<sup>®</sup>-BAC1 and Rtx<sup>®</sup>-BAC2 columns and a Perkin-Elmer HS 40 headspace autosampler.

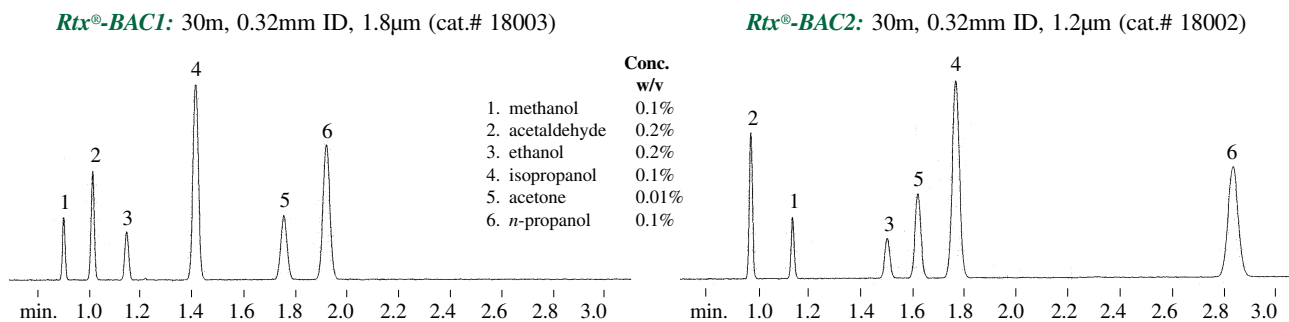

Dual-column analysis using a two-hole ferrule. 1.0mL headspace sample of a blood alcohol mix.

**Oven temp.:** 40°C isothermal; **Inj. temp.:** 200°C; **Carrier gas:** He; **Sample equilibration temp.:** 70°C; **Sample equilibration time:** 15 min.; **Vial pressure:** 30psi; **Vial pressurization time:** 0.15 min.; **Vial sampling time:** 0.01 min.; **Transfer line:** 0.32mm ID FS Hydroguard™ tubing; **Transfer line temp.:** 200°C; **Injection port sleeve:** 2mm ID; **Split flow:** 20mL/min.

A balanced pressure sampling unit was used to transport the sample to the GC. This type of sampling works better with columns that require higher head pressure (smaller ID) to improve flow efficiencies. 0.32mm ID analytical columns were chosen for this application because of their higher operating pressure. Optimal column performance during headspace analysis depends on GC/headspace system set up. Band broadening can occur if there is excess dead volume in the sample flow path between the sample valve and the head of the column. Low volume inlet liners or interfaces in the injection port should be used to reduce the amount of excess volume at the exit end of the transfer line. A 2mm ID liner was used in this analysis to reduce dead volume and maintain narrow peak widths. High carrier gas flow rates through the transfer line also can be used to maintain narrow sample bandwidths and speed up sample transfer to the column head. A flow of 40mL-per-minute was used to optimize the analysis on the Perkin-Elmer HS 40 system.

Simulated blood alcohol samples were prepared and analyzed using a modification of a procedure published by Christmore et al.<sup>2</sup> *n*-Propanol was used as the internal standard and was prepared at a concentration of 0.03g/dL in 1.0M ammonium sulfate as a diluent. Five milliliters of diluent were added to 1mL of sample in a 20mL headspace vial (Figure 12).

These conditions (PE Auto SYS GC and HS 40 headspace autosampler), combined with unique columns (Rtx®-BAC1 and Rtx®-BAC2), provided excellent accuracy and precision in the analysis of blood alcohol with complete resolution in less than 3 minutes. Calibration curves were constructed using concentrations ranging from 0.01% to 0.5% ethanol. Correlation coefficients above 0.999 were easily obtained for all compounds. Response factor repeatability was less than  $\pm 1\%$  standard deviation while analyzing six samples at a concentration of 0.2% ethanol. Based on our experimentation, a system detection limit of 0.001% ethanol should be achievable while maintaining a minimum signal-to-noise ratio of 10. For more information on this analysis request, request cat.# 59548.

#### **Quantitation Technique for USP <467> (External Standard)**

*This technique uses a separate sample (standard) that has the compounds of interest at known concentrations in the same matrix. This technique is advantageous if various samples are being analyzed, and all compounds of interest can be assayed using a single set external standards.*

#### **USP <467>**

A new test for the gas chromatographic (GC) analysis of Organic Volatile Impurities (OVI) in pharmaceutical products was published in the Third Supplement to the US Pharmacopoeia (USP) XXII-NF XVII, which became effective November 15, 1990.

Since its original appearance in the USP, this testing protocol has undergone many revisions and additions.<sup>1-6</sup> The most recent of which was published as USP 24, effective January 1, 2000.<sup>7</sup> The biggest change was to the limit test concentrations, which now match the European Pharmacopoeia (EP) concentrations and the ICH guidelines for the five USP <467>-regulated solvents.<sup>8,9</sup>

#### *Limit Test Concentrations for USP <467>*

benzene	<b>New</b>	2ppm
chloroform		60ppm
1,4-dioxane		380ppm
methylene chloride		600ppm
trichloroethene		80ppm

USP issued an in-process revision announcing that the limit test for benzene is not required unless a specific limit for benzene is included in the individual drug monograph.<sup>10</sup> The revision was needed because Methods I and V were unable to detect benzene at 2ppm. Currently, Method IV is the only method that detects benzene at 2ppm. It is anticipated that USP will make more revisions to benzene detection limits during 2000.

USP also has clarified that a 5m phenyl-methyl guard column is not needed for the Method IV, headspace analysis.<sup>10</sup>

**Figure 13** shows an analysis using Method IV at the revised concentrations, the method-specified sample preparation procedure, a G43 analytical column, and no guard column.

USP made changes in 1997 to overcome the difficulties resulting from unregulated solvents coeluting with regulated solvents, and thereby causing over-representation of their concentrations using GC/flame ionization detection (FID) methods.<sup>11</sup> GC/mass spectrometry (MS) or a second, validated column having a different stationary phase may be used to confirm the presence of the coeluting unregulated solvent and report the correct concentration of regulated solvent. For more information on this analysis request, request cat.# 59577A.

**Table IV**

*Organic Volatile Impurities (OVI) methods and corresponding chromatographic systems.*

#### **Method IV - Static Headspace**

6% cyanopropylphenyl/94% dimethylpolysiloxane (G43)  
30m, 0.53mm ID, 3.0 $\mu$ m  
(Rtx®-G43 column, cat.# 16085-126)

#### **Method for Coated Tablets - Static Headspace**

0.2% polyethylene glycol, MW 1500 (G39)  
on graphitized carbon (S7)  
(0.2% Carbowax® 1500 on 80/100 CarboBlack™ C packed column, cat. # 80122)

**Figure 13**

The Rtx<sup>®</sup>-G43 column provides the resolution and detection limits needed for USP 24<sup>th</sup> edition <467> revised limit test concentrations in USP Method IV.

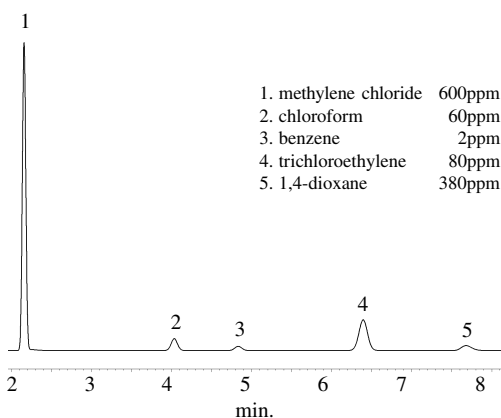

**Sample Preparation:** 100 $\mu$ L of cat.# 36007 in 5mL distilled water, 1 gram sodium sulfate in a 20mL headspace vial.

30m, 0.53mm ID, 3.0 $\mu$ m Rtx<sup>®</sup>-G43 (cat.# 16085)

**Oven temp.:** 40°C (hold 20 min.) to 240°C @ 35°C/min. (hold 20 min.);

**Inj. temp.:** 140°C, 1mm split sleeve (cat.# 20916);

**Det. temp.:** 260°C;

**FID sensitivity:** 1.25 x 10<sup>-11</sup> AFS;

**Carrier gas:** helium, 3.5psi constant pressure, 35cm/sec. set @ 40°C; **Split ratio:** 2:1; ThermoQuest HS 2000 Headspace Autosampler Vial 80°C, 60 min. shaker on.

Comments in the September/October 1992 Pharmacopoeial Forum<sup>3</sup> propose the use of dimethyl sulfoxide as the solvent for stock standard, but this has not been approved as of the date of this publication.

In regards to this proposal, an investigation was conducted to determine if there were significant changes in results if dimethyl sulfoxide was used as the diluent for stock standard. Similar RSDs can be obtained when stock solutions are diluted in dimethyl sulfoxide as opposed to solutions made with water (**Table V**).

**Table V**

Percent RSD for stock solutions in water vs. DMSO

Stock Solvent	Methylene Chloride	Chloroform	Benzene	1,1,1-Trichlorethylene	1,4-Dioxane
Water	10.19	10.64	14.52	16.75	18.61
Water w/ Sample	8.29	9.25	11.3	13.38	15.26
DMSO	7.37	8.59	8.18	8.01	14.43
DMSO w/ Sample	7.25	7.54	8.8	8.67	7.37

For customer service, call  
**800-356-1688, ext. 3**  
 (814-353-1300, ext. 3)

or call your local  
 Restek representative.

## Quantitation Techniques for European Pharmacopoeia

### (External Standard)

This technique uses a separate sample (standard) that has the compounds of interest at known concentrations in the same matrix. This technique is advantageous if various samples are being analyzed, and all compounds of interest can be assayed using a single set external standards.

### (Standard Addition)

The standard addition technique uses known amounts of the compounds of interest and adds it to the existing sample. The original concentration of the compounds of interest are then calculated using linear regression.

### Peak List for Figure 15

Headspace injection of 28 Class 1 and Class 2 residual solvents for pharmaceutical processing. Prepared at the regulatory limit concentration. Samples shaken and heated at 80°C for 15 minutes, 1mL headspace injection.

1. methanol
2. 1,1-dichloroethene
3. acetonitrile
4. methylene chloride (dichloromethane)
5. hexane (C6)
6. *cis*-1,2-dichloroethene
7. nitromethane
8. chloroform
9. cyclohexane
10. 1,1,1-trichloroethane
11. carbon tetrachloride
12. benzene
13. 1,2-dimethoxyethane
14. 1,2-dichloroethane
15. trichloroethylene (1,1,2-trichloroethene)
16. methylcyclohexane
17. 1,4-dioxane
18. pyridine
19. toluene
20. 2-hexanone
21. chlorobenzene
22. DMF
23. ethylbenzene
24. *m*-xylene
25. *p*-xylene
26. *o*-xylene
27. N,N-dimethylacetamide
28. 1,2,3,4-tetrahydronaphthalene

## European Pharmacopoeia Tests

The International Conference on Harmonization (ICH) has proposed a set of guidelines for residue solvent testing in pharmaceutical formulation and the European Pharmacopoeia (EP) was the first to revise their regulations.<sup>7,8</sup> However, these guidelines are challenging, containing over 60 compounds of regulatory interest to manufacturers of active substances, excipients, and medicinal products. The EP methods also allow testing limits based on either a concentration limit in a product, or calculated from the maximum daily dosage of the product and the permissible daily exposure limit of the solvent. These technical challenges affect the sampling method and capillary column needed to ensure precise and accurate results.

The recommended primary capillary column for EP residual solvent testing is the Rtx®-1301. The Rtx®-1301 column shows excellent resolution of most EP Class 1 and Class 2 compounds at the regulation limit concentration (**Figure 14**). Restek also offers Stabilwax® columns, the recommended confirmational column for European Pharmacopoeia residual solvent testing. For more information on this analysis request, request cat.# 59107.

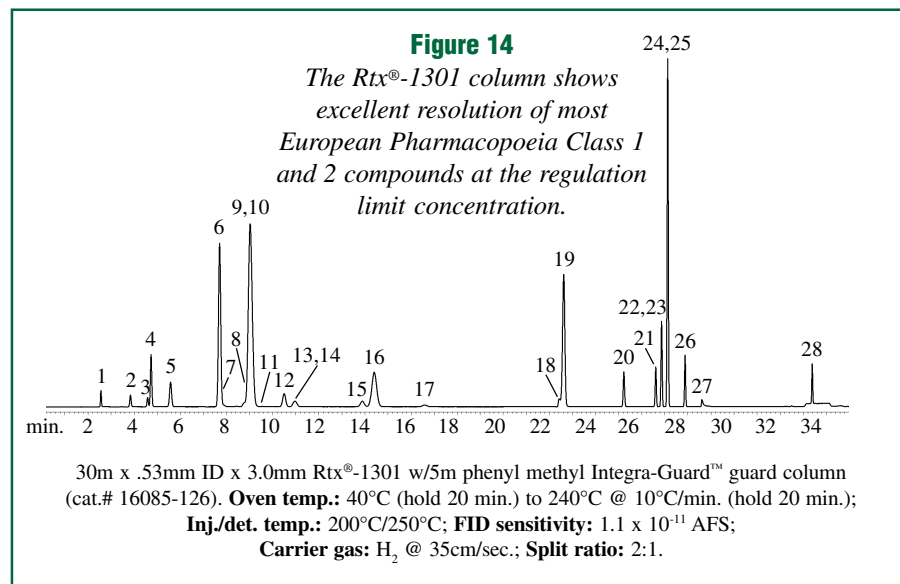

### Guide References

1. M.S. Bergren and D.W. Foust, "Comments on USP General Chapter, Organic Volatile Impurities <467>, and Associated Monograph Proposals," *Pharmacopoeial Forum*, May/June 1991, Vol. 17, No. 3, pp. 1963-1968.
2. J.A. Krasowski, H. Dinh, T.J. O'Hanlon, R.F. Lindauer, "Comments on Organic Volatile Impurities, Method 1, <467>," *Pharmacopoeial Forum*, May/June 1991, Vol. 17, No. 3, pp. 1969-1972.
3. *Pharmacopoeial Forum*, March/April 1991, Vol. 17, No. 2, p. 1653.
4. Fifth Supplement, USP-NF, Organic Volatile Impurities <467>, Nov. 15, 1991, pp. 2706-2708.
5. "Organic Volatile Impurities <467>," *Pharmacopoeial Forum*, May-June 1993, Vol. 19, No. 3, pp. 5335-5337.
6. *Pharmacopoeial Forum*, September/October 1992, Vol. 18, No. 5, p. 4028.
7. USP 24/NF 19, <467> Organic Volatile Impurities, (1877-1878).
8. "ICH Harmonized Tripartite Guideline, Impurities: Guideline for Residual Solvents," *The Fourth International Conference on Harmonization*, July 17, 1997.
9. European Pharmacopoeia, Supplement 1999, pp. 14-15, 208.
10. *Pharmacopoeial Forum*, November - December 1999, Vol. 25, Number 6, (9223 - 9224).
11. Sixth Supplement, USP-NF, Organic Volatile Impurities <467>, May 15, 1997, pp. 3766-3768.

*These references are not available from Restek.*

## Recommended Static Headspace Analysis Products:

### Capillary Columns

#### *Rtx<sup>®</sup>-BAC1 Capillary Columns*

ID (mm)	df (μm)	30-Meter
0.32	1.80	18003
0.53	3.00	18001

#### *Rtx<sup>®</sup>-G27 Integra-Guard™ Column*

ID (mm)	df (μm)	30-Meter
0.53	5.00	10279-126

#### *Rtx<sup>®</sup>-5 Capillary Columns*

ID (mm)	df (μm)	30-Meter
0.32	3.00	10284
0.53	5.00	10279

#### *Stabilwax<sup>®</sup> Capillary Columns*

ID (mm)	df (μm)	30-Meter
0.32	0.25	10624
0.53	0.50	10640
0.53	1.00	10655

### Press-Tight<sup>®</sup> Connectors

#### *Universal Press-Tight<sup>®</sup> Connectors*

- Ideal for connecting guard columns to analytical columns.
- Repair broken columns.
- Connect column outlets to transfer lines.

5-pk.	25-pk.	100-pk.
20400	20401	20402

#### *Universal Angled Press-Tight<sup>®</sup> Connectors*

- Ideal for connecting guard columns to analytical columns.
- Designed at an angle approximating the radius of a capillary column.
- Reduces strain on column-end connections.

5-pk.	25-pk.	100-pk.
20446	20447	20448

#### *Rtx<sup>®</sup>-BAC2 Capillary Columns*

ID (mm)	df (μm)	30-Meter
0.32	1.20	18002
0.53	2.00	18000

#### *Rtx<sup>®</sup>-G43 Integra-Guard™ Column*

ID (mm)	df (μm)	30-Meter
0.53	3.00	16085-126

#### *Rtx<sup>®</sup>-1301 Capillary Columns*

ID (mm)	df (μm)	30-Meter
0.32	1.50	16069
0.53	3.00	16085

#### *Universal ‘Y’ Press-Tight<sup>®</sup> Connectors*

- Split sample flow onto two columns.
- Split a single column flow into two different detectors.
- Perform confirmational analysis with a single injection.

each	3-pk.
20405	20406

#### *Universal Angled ‘Y’ Press-Tight<sup>®</sup> Connectors*

- Alleviates column-end connection strain.
- Inlet and outlet ends conform to the column radius.
- Perform confirmational analysis with a single injection.

each	3-pk.
20403	20404

### Guard Columns

#### *Fused Silica Guard Columns*

ID (mm)	OD (mm)	5-Meter
0.32	0.45 ± 0.04	10044
0.53	0.69 ± 0.05	10045

#### *Integra-Guard™ Guard Columns*

ID (mm)	OD (mm)	Length	Suffix
0.32	0.45 ± 0.04	5m	-125
0.32	0.45 ± 0.04	10m	-128
0.53	0.69 ± 0.05	5m	-126
0.53	0.69 ± 0.05	10m	-129

For technical support, call  
**800-356-1688, ext. 4**

(814-353-1300, ext. 4)

or call your local  
 Restek representative.

#### *Universal Angled Siltek™-Deactivated Press-Tight<sup>®</sup> Connectors*

- Siltek™ deactivation for inert pathways to maintain sample integrity.
- Ideal for connecting guard columns to analytical columns.
- Designed at an angle approximating the radius of a capillary column.

5-pk.	25-pk.	100-pk.
20482	20483	20484

## Analytical Reference Materials

### USP <467> Reference Material Mixes

#### USP <467> Calibration Mix #2

benzene	100µg/mL
chloroform	50
1,4-dioxane	100
methylene chloride	500
trichloroethene	100

Prepared in methanol, 1mL/ampul

**Ea.:** cat.# 36002    **10-pk.:** cat.# 36102

#### USP <467> Calibration Mix #4

benzene	2µg/mL
chloroform	60
1,4-dioxane	380
methylene chloride	600
trichloroethene	80

Prepared in methanol, 1mL/ampul

**Ea.:** cat.# 36006    **10-pk.:** cat.# 36106

#### USP <467> Calibration Mix #3

benzene	100µg/mL
chloroform	50
1,4-dioxane	100
methylene chloride	500
trichloroethene	100

Prepared in DMSO, 1mL/ampul

**Ea.:** cat.# 36004    **10-pk.:** cat.# 36104

#### USP <467> Calibration Mix #5

benzene	2µg/mL
chloroform	60
1,4-dioxane	380
methylene chloride	600
trichloroethene	80

Prepared in DMSO, 1mL/ampul

**Ea.:** cat.# 36007    **10-pk.:** cat.# 36107

### European Pharmacopoeia/ICH Reference Material Mixes

#### Class 1 Mix

benzene	2µg/mL
carbon tetrachloride	4
1,2-dichloroethane	5
1,1-dichloroethene	8
1,1,1-trichloroethane	1500

Prepared in water:dimethylsulfoxide 90:10, 1mL/ampul

Each	5-pk.	10-pk.
36228	36228-510	36328

#### Class 2 Mix A

chlorobenzene	360µg/mL
cyclohexane	3880
cis-1,2-dichloroethene	1870
dichloromethane	600
ethylbenzene	369
hexane	290
methylcyclohexane	1180
N,N-dimethylformamide	880
toluene	890
1,1,2-trichloroethene	80
m-xylene	1302
o-xylene	195
p-xylene	304

Prepared in water:dimethylsulfoxide 90:10, 1mL/ampul

Each	5-pk.	10-pk.
36229	36229-510	36329

#### Class 2 Mix B

acetonitrile	410µg/mL
chloroform	60
1,2-dimethoxyethane	100
N,N-dimethylacetamide	1090
1,4-dioxane	380
1,2,3,4-tetrahydronaphthalene (tetraline)	100
2-hexanone	50
methanol	3000
nitromethane	50
pyridine	200

Prepared in water:dimethylsulfoxide 90:10, 1mL/ampul

Each	5-pk.	10-pk.
36230	36230-510	36330

#### Class 2 Mix C

2-ethoxyethanol	160µg/mL
ethylene glycol	620
formamide	220
2-methoxyethanol	50
N-methylpyrrolidone	4840
sulfolane	160

Prepared in water, 1mL/ampul

Each	5-pk.	10-pk.
36231	36231-510	36331

For customer service, call  
**800-356-1688, ext. 3**

(814-353-1300, ext. 3)

or call your local  
Restek representative.



## GC Accessories

### Headspace Autosampler Vials

Description	100-pk.	1000-pk.
6mL Clear Vial	21166	21167
10mL Clear Vial, Flat Bottom	24683	24684
10mL Clear Vial, Rounded Bottom	21164	21165
20mL Clear Vial, Flat Bottom	24685	24686
20mL Clear Vial, Rounded Bottom	21162	21163
27mL Clear Vial	21160	21161

### 20mm Aluminum Seals w/Septa, Assembled

Description	100-pk.	1000-pk.
Silver Seal w/ PTFE/Gray Butyl Rubber	21761	21762
Silver Seal w/ PTFE/Silicone	21763	21764
Pressure Release, Silver Seal w/ PTFE/ Gray Butyl Rubber Septa <125°C	21765	21766
Pressure Release, Silver Seal w/ PTFE/ Silicone Septa >125°C	21767	21768

### Aluminum Seal Crimper and Decapper

The crimper is adjustable for optimized sealing performance. It also is comfortable enough for pro- longed use. For chromatographers who need to save, transfer, or dispose of their samples, we provide a decapper that allows the user to remove a crimp-top cap safely and easily. If you haven't used an aluminum seal decapper, order one today!

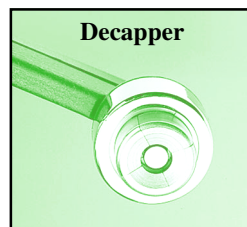
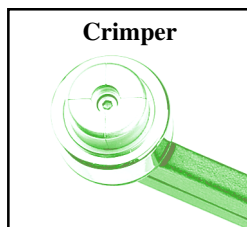
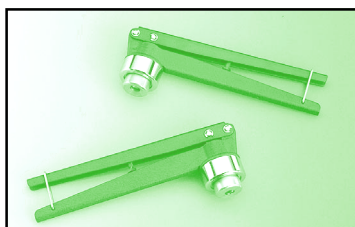

Size	Crimper	Decapper
8mm	21735	21736
11mm	21170	21171
13mm	21739	21740
20mm	21737	21738

### Thermolite® Septa

Septum Diameter	25-pk.	50-pk.	100-pk.
9.5mm (3/8")	20359	20360	20361
10mm	20378	20379	20380
11mm (7/16")	20363	20364	20365
12.5mm (1/2")	20367	20368	20369
17mm	20384	20385	20386
Shimadzu Plug	20372	20373	20374

To request a FREE sample of Thermolite® septa, call 800-356-1688, ext. 5, or your local Restek representative.



**Capillary Ferrules***(for 1/16" compression-type fittings)*

Ferrule ID (mm)	Fits		Vespel®/ Graphite 50-pk.
	Column ID (mm)	Graphite 50-pk.	
0.4	0.25	20227	20229
0.5	0.32	20228	20231
0.8	0.53	20224	20230

**Two-Hole Ferrules***(for 1/16" compression-type fittings)*



Ferrule ID (mm)	Fits		Vespel®/ Graphite 5-pk.
	Column ID (mm)	Graphite 5-pk.	
0.4	0.25	20235	20241
0.5	0.32	20235	20242
0.8	0.53	20245	20246

**Graphite Ferrules for M4 Fittings***(for QCQ Fisons 8000 & TRACE 2000)*





Ferrule ID (mm)	Fits		Graphite 2-pk.	Graphite 10-pk.
	Column ID (mm)	Graphite 2-pk.		
0.4	0.18–0.25	20280	20281	
0.5	0.32	20282	20283	
0.8	0.50 & 0.53	20284	20285	

*Please request the Inlet Supplies Guide (#59893) for a comprehensive list of Restek's inlet supplies.*

**Inlet Liners for HP/Finnigan GCs**

Liner	ID/OD/length	ea.	5-pk.	25-pk.
 2mm Splitless	2.0 x 6.5 x 78.5	20712	20713	20714
 Gooseneck Splitless (2mm)	2.0 x 6.5 x 78.5	20795	20796	20797
 Recessed Gooseneck (2mm)	2.0 x 6.5 x 78.5	20980	20981	20982
 1mm Split	1.0 x 6.3 x 78.5	20972	20973	—



**Inlet Liners for Varian GCs**

Liner	ID/OD/length	ea.	5-pk.	25-pk.
 1mm Split	1.0 x 6.3 x 72	20970	20971	—
 2mm Splitless	2.0 x 6.3 x 74	20721	20722	20723
 Open 0.5mm ID	0.5 x 5.0 x 54	20992	20993	—
 Open 0.75mm ID	0.75 x 5.0 x 54	21714	21715	21716

**Inlet Liners for Shimadzu GCs**

Liner	ID/OD/length	ea.	5-pk.	25-pk.
 17A 1mm Split	1.0 x 5.0 x 94	20976	20977	20978

**Inlet Liners for Perkin-Elmer GCs**

Liner	ID/OD/length	ea.	5-pk.	25-pk.
 2mm Splitless	2.0 x 5.0 x 100	20730	20731	20732
 Auto SYS Splitless w/Wool (2mm)	2.0 x 6.2 x 92.1	20829	20830	20831
 Auto SYS XL Split/Splitless w/ wool	2.0 x 4.0 x 81.2	21717	21718	—

**Inlet Liners for CE Instruments/ThermoQuest GCs***for 5000 and 6000 GCs*

Liner	ID/OD/length	ea.	5-pk.	25-pk.
 2mm Splitless	2.0 x 5.5 x 79.5	20811	20812	20813

*for TRACE and 8000 GCs*

Liner	ID/OD/length	ea.	5-pk.	25-pk.
 1mm Split	1.0 x 8.0 x 105	20916	20917	—

For technical support, call  
**800-356-1688, ext. 4**  
 (814-353-1300, ext. 4)

or call your local  
 Restek representative.

### Hewlett-Packard 1/16-Inch Capillary Inlet Adaptor Fitting Kit

Restek has specially engineered a high-precision, 1/16-inch fitting that uses standard size, two-hole capillary ferrules. The fitting kit comes with everything needed for dual-column confirmational analysis using 0.25 and 0.32mm ID capillary columns (two-hole ferrules must be ordered separately).

**Capillary Inlet Adaptor Fitting Kit** (for 0.25/0.32mm ID columns): cat.# 20633

**Replacement Inlet Seal** (1.2mm hole): cat.# 20390, (2-pk.); cat.# 20391, (10-pk.)



### Hewlett-Packard 1/8-Inch Capillary Inlet Adaptor Fitting Kit

Restek has specially engineered a high-precision, 1/8-inch fitting that uses standard 1/8-inch, two-hole capillary ferrules. The fitting kit comes with everything needed for installation.

**1/8-inch Capillary Inlet Adaptor Fitting Kit** (for 0.53mm ID columns): cat.# 20645

**Replacement Inlet Seal** (1/16-inch hole): cat.# 20392, (2-pk.); cat.# 20393, (10-pk.)



### Low-Volume Injector for Hewlett-Packard 5890 Septum Packed Purge Port

Includes a 1/16-inch nut, a 1/16-inch ferrule, a base nut and 1/4-inch Vespel®/graphite ferrule, a 1/16-inch capillary nut, a 5-pack of low-bleed plug septa, and a special low-mass septa nut. Order appropriate capillary ferrules separately.

#### Description

#### Kit

LVI for HP 5890 Septum Packed Purge Port

cat.# 21698



### Low-Volume Injector for Hewlett-Packard and Varian GCs

Includes a 1/16-inch nut, a 1/16-inch ferrule, a base nut and 1/4-inch Vespel®/graphite ferrule, a 1/16-inch capillary nut, a 5-pack of low-bleed plug septa, and a special low-mass septum nut. Order appropriate capillary ferrules separately.

#### Description

#### Kit

LVI for HP Split/Splitless GC inlets

cat.# 21692

LVI for Varian Split/Splitless GC inlets

cat.# 21693



### Restek Leak Detective™ Electronic Leak Detector

The Leak Detective™ responds in less than 2 seconds to trace leaks of gases with thermal conductivities different than air. Helium or hydrogen can be detected at  $3 \times 10^{-4}$  cc/sec.\* or at an absolute concentration as low as 200ppm. Leaks are indicated by an audible alarm, as well as by an LED readout. (Batteries and AC adaptor included.)

\*Caution: not designed for determining leaks of combustible gases.

#### Description

#### Each

Restek Leak Detective™ Electronic Leak Detector (110 volts)

cat.# 21607

Restek Leak Detective™ Electronic Leak Detector (220 volts)

cat.# 21609



### Restek Veri-Flow 500 Electronic Flowmeter

- Calculates linear velocity based on column ID.
- Measures N<sub>2</sub>, He, H<sub>2</sub>, 5% Ar/Me, and Air.
- Measures split flow and mass flow.
- Has pulse-free operation that will not interfere with EPCs.
- Reads flow accurately from 5 to 500mL/min.

#### Description

#### Each

Restek Veri-Flow 500 Electronic Flowmeter (110 volts)

cat.# 21643

Restek Veri-Flow 500 Electronic Flowmeter (220 volts)

cat.# 21645



# Count on Restek for Customer Service & Technical Support

*We do what it takes to meet & satisfy our customer's needs!*

## Customer Service Team

Restek's highly trained customer service team looks forward to working with you. We are here when you need to place an order, track a package, check the status of an open order, or request a price quote. We will suggest time- and money-saving options and are dedicated to getting your products to you *fast*. Because we know how busy you are, we will do whatever it takes to simplify your work. That's what having the best customer service in the business is all about! Our extended hours are 8:00 a.m. to 6:00 p.m. EST, Monday thru Friday.



Visit our web site at  
[www.restekcorp.com](http://www.restekcorp.com).

## Chromatography Information Services (CIS)



Our newly-formed Chromatography Information Services (CIS) team focuses its resources on innovating ways to teach the art and science of chromatography. This knowledge management group is dedicated to exploring and implementing ways of capturing, organizing, and disseminating chromatographic knowledge, experience, and wisdom to our internal and external customers worldwide. CIS enhances Restek's vision of becoming "the first company chromatographers think of whenever they have a separation need or chromatographic question."

For customer service, call  
**800-356-1688, ext. 3**  
(814-353-1300, ext. 3)

or your local Restek representative.

## Technical Service Department

Our Technical Service Department is staffed with over 35 experienced chemists from various departments within Restek on rotating shifts. This group is able to answer our customers' questions concerning accessories, applications, chemical standards, columns, education, method development, metal passivation (Silcosteel®) and troubleshooting for GC, HPLC, and Air Analysis. Our regular technical service hours are 8:00 a.m. to 7:00 p.m., Monday through Thursday, and 8:00 a.m. to 5:00 p.m. on Fridays.



For technical support, call  
**800-356-1688, ext. 4**  
(814-353-1300, ext. 4)

or your local Restek representative.

Lit. Cat.# 59895A

**RESTEK**

ISO 9001  
REGISTERED

©Copyright 2000, Restek Corp.

### Restek (U.S.):

110 Benner Circle • Bellefonte, PA 16823  
800-356-1688 • 814-353-1300  
fax: 814-353-1309

### Restek France:

(33) 01 60 78 32 10  
restekfr@club-internet.fr

### Restek GmbH:

(49) 06172 2797 0  
RESTEK-GMBH@t-online.de

### Thames Restek U.K., Ltd.:

(44) 01753 624111  
SALESTHRES@aol.com

*For permission to reproduce any portion of this technical guide, please contact Restek's publications/graphics department by phone (ext. 2128) or FAX (814) 353-9278.*